



# Technical Data Sheet

## 5484/GADC-AMPA/X/MS

### Features

- High luminous intensity output
- Oval Shape
- Well defined spatial radiation
- Wide viewing angle ( $2\theta_{1/2}$ ) :  $110^\circ / 40^\circ$
- UV resistant epoxy
- The product itself will remain within RoHS compliant version



### Descriptions

- This precision optical performance oval LED is specifically designed for passenger information signs
- This lamp has matched radiation patterns with red and blue mixing color applications

### Applications

- Color graphic signs
- Message boards
- Variable message signs (VMS)
- Commercial outdoor advertising

### Device Selection Guide

LED Part No.	Chip Material	Emitted Color	Lens Color	Stopper
5484/GADC-AMPA/MS	InGaN	Brilliant Green	Green Diffused	No
5484/GADC-AMPA/P/MS				Yes

### Package Dimensions

Stopper Type

No Stopper Type

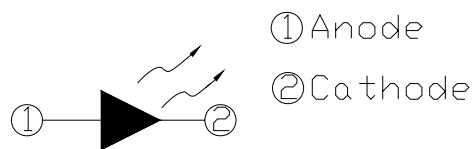
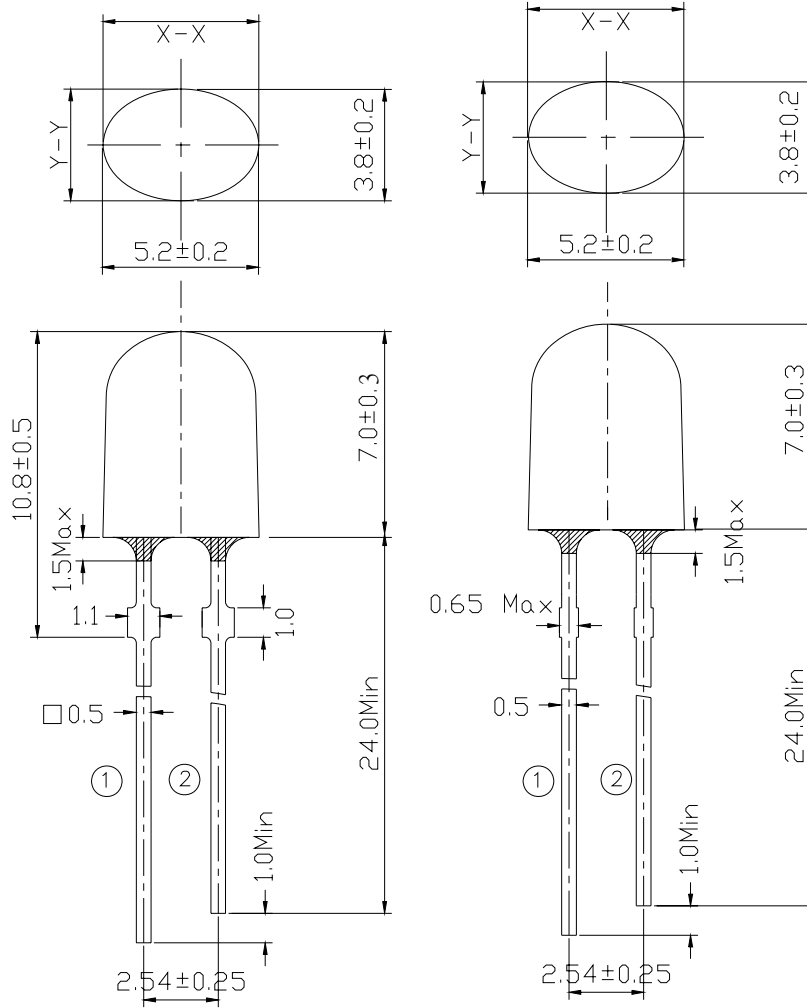

### Notes:

- All dimensions are in millimeters, tolerance is 0.25mm except being specified.
- Protruded resin under flange is 1.5mm Max LED.
- Bare copper alloy is exposed at tie-bar portion after cutting.



# Technical Data Sheet

## 5484/GADC-AMPA/X/MS

### Absolute Maximum Rating ( $T_a=25^{\circ}\text{C}$ )

Parameter	Symbol	Absolute Maximum Rating	Unit
Forward Current	$I_F$	30	mA
Pulse Forward Current (Duty1/10@ 1KHz)	$I_{FP}$	100	mA
Operating Temperature	$T_{opr}$	-40 ~ +85	$^{\circ}\text{C}$
Storage Temperature	$T_{stg}$	-40 ~ +100	$^{\circ}\text{C}$
Soldering Temperature	$T_{sol}$	260 $\pm$ 5	$^{\circ}\text{C}$
Power Dissipation	$P_d$	100	mW
Reverse Voltage	$V_R$	5	V

Notes: Soldering time  $\leq$  5 seconds.

### Electro-Optical Characteristics ( $T_a=25^{\circ}\text{C}$ )

Parameter	Symbol	Min.	Typ.	Max.	Unit	Condition
Luminous Intensity	$I_V$	1800	2250	3600	mcd	$I_F=20\text{mA}$
Viewing Angle	$2\theta_{1/2}$	--	X:110 Y:40	--	deg	
Peak Wavelength	$\lambda_p$	--	518	--	nm	
Dominant Wavelength	$\lambda_d$	525	530	535		
Spectrum Half width	$\Delta\lambda$	--	35	--		
Forward Voltage	$V_F$	2.8	3.4	3.6	V	$V_R=5\text{V}$
Reverse Current	$I_R$	--	--	50	$\mu\text{A}$	

### Rank Combination ( $I_F=20\text{mA}$ )

Rank	M	N	P
Luminous Intensity	1800~2250	2250~2850	2850~3600

\*Measurement Uncertainty of Luminous Intensity:  $\pm 15\%$

Unit:mcd

Rank	0	1	2	3
Forward Voltage	2.8~3.0	3.0~3.2	3.2~3.4	3.4~3.6

\*Measurement Uncertainty of Forward Voltage:  $\pm 0.1\text{V}$

Unit:V

Rank	1	2
Dominant Wavelength	525~530	530~535

\*Measurement Uncertainty of Dominant Wavelength  $\pm 1.0\text{nm}$

Unit:nm

\*The quantity ratio of the ranks is decided by EVERLIGHT.

### Typical Electro-Optical Characteristics Curves

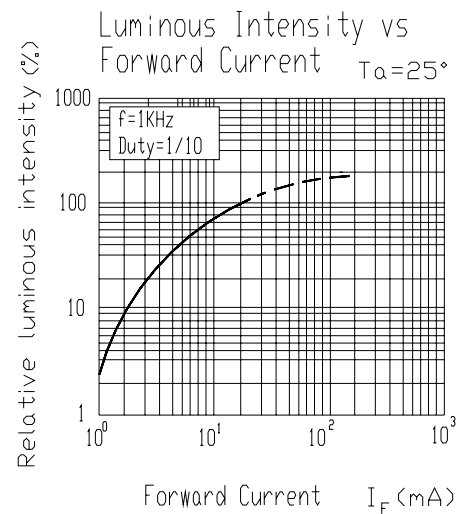
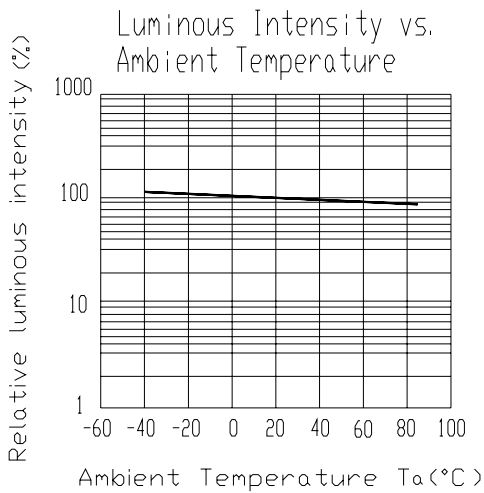
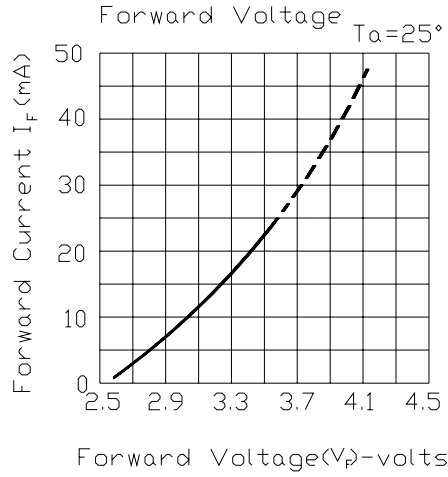
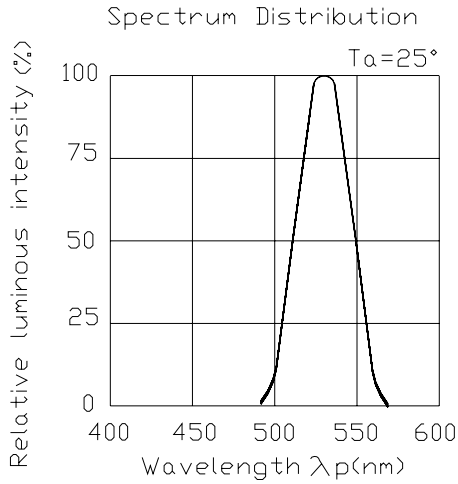

Forward Current Derating Curve

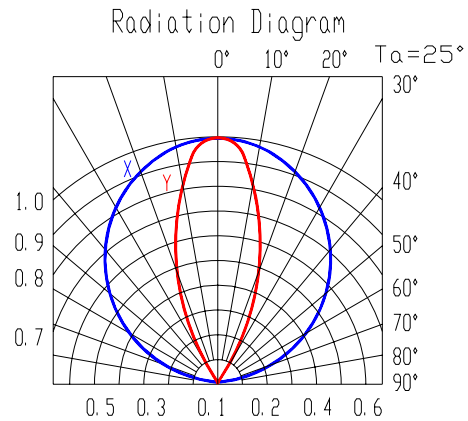
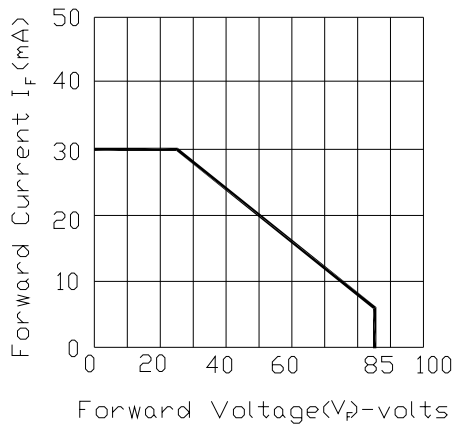



# Technical Data Sheet



## 5484/GADC-AMPA/X/MS

### Packing Quantity Specification

1.500PCS/1Bag , 5Bags/1Box

2.10Boxes/1Carton

### Label Form Specification

<b>EVERLIGHT</b>	
CPN:	
P/N:	
	RoHS
5484/GADC-AMPA/X/MS	
QTY :	CAT:
	HUE:
LOT NO :	REF:
	
MADE IN TAIWAN	

CPN: Customer's Production Number

P/N : Production Number

QTY: Packing Quantity

CAT: Ranks of Luminous Intensity and Forward Voltage

HUE: Rank of Dominant Wavelength

REF: Reference

LOT No: Lot Number

MADE IN TAIWAN: Production Place



# Technical Data Sheet

## 5484/GADC-AMPA/X/MS

### Notes

1. Above specification may be changed without notice. EVERLIGHT will reserve authority on material change for above specification.
2. When using this product, please observe the absolute maximum ratings and the instructions for using outlined in these specification sheets. EVERLIGHT assumes no responsibility for any damage resulting from use of the product which does not comply with the absolute maximum ratings and the instructions included in these specification sheets.
3. These specification sheets include materials protected under copyright of EVERLIGHT corporation. Please don't reproduce or cause anyone to reproduce them without EVERLIGHT's consent.
4. Soldering Condition

Careful attention should be paid during soldering. When soldering, leave more than 3mm from solder joint to case, and soldering beyond the base of the tie bar is recommended.

Avoiding applying any stress to the lead frame while the LEDs are at high temperature particularly when soldering.

Recommended soldering conditions:

Hand Soldering		DIP Soldering	
Temp. at tip of iron	400°C Max. (30W Max.)	Preheat temp.	100°C Max. (60 sec Max.)
Soldering time	3 sec Max.	Bath temp.	265 Max.
Distance	3mm Min.(From solder joint to case)	Bath time.	5 sec Max.
		Distance	3mm Min.

**EVERLIGHT ELECTRONICS CO., LTD.**  
Office: No 25, Lane 76, Sec 3, Chung Yang Rd,  
Tucheng, Taipei 236, Taiwan, R.O.C

Tel: 886-2-2267-2000, 2267-9936  
Fax: 886-2267-6244, 2267-6189, 2267-6306  
<http://www.everlight.com>